

USER MANUAL

# CANON CD5s

housing



**SUBAL**



Dear customer,



It is my great honor and pleasure that you have chosen our product.

SUBAL, one of the oldest manufacturers of underwater housings and equipments, always trying to follow new trends and to complement its range of products. With our experience and knowledge, for almost four decades, we cover with our quality equipment all leading manufacturers of cameras and video cameras. The result is that a large number of world-renowned underwater photographers uses SUBAL equipment.

I hope that you will take some of the memorable moments with your SUBAL!

CEO Subal  
Karl Harald

## CONTENTS

GENERAL	5
USE AND MAINTAINANCE OF O-RINGS	6
PREPARING THE CAMERA	7
PREPARING THE LENS	8
OPENING THE HOUSING	9
CLOSING THE HOUSING	10
INSERTING THE CAMERA	10
THE INTERCHANGEABLE PORT SYSTEM	12
CHANGING A LENS	14
OPERATING THE FUNCTIONS	14
MOUNTING AND CONNECTING A FLASH UNIT	15
ADDITIONAL ACCESSORIES	16
SUBAL CIRCUIT FOR NIKON AND CANON (CONNECTION DIAGRAM)	17
CHECK-LIST	18
GUARANTEE	19
FRONT HOUSING PART EXPLODE VIEW	21
FRONT PARTS LIST	23
BACK HOUSING PART EXPLODE VIEW	25
BACK PARTS LIST	27

**We congratulate you on your choice of the SUBAL CD5s underwater housing for the Canon 5Ds.**

During the conception and design of the housing, considerable attention was directed towards the application of advantages and unique features of the state-of-the art 7D camera technology, making them available to the underwater photographer for the first time.

An extensive range of high quality lens ports allows the fitting of a number of interesting lenses, which is a great advantage over all other amphibious cameras available today. This will facilitate the most varied photographic tasks.

To get the best results, to take full advantage of the system and for the protection of your camera, we recommend you take careful note of all the hints contained in these instructions for use.

**We hope you enjoy using the SUBAL CD5s!**

## GENERAL

**It will be assumed that the user of the camera is fully confident and trained in the use of diving equipment.**



The demands on underwater photographic equipment are very high - pressure, aggressiveness of salt water and not least, improper use results in a risk which can only be avoided by careful handling.

**Therefore assemble carefully and calmly. Check twice!**

During the production process all functions and the tightness of each individual housing are tested and checked several times. Nevertheless, we recommend to test dive the housing first **without the camera fitted**, to ensure that all is well.

After closing the housing, check everything as recommended on the checklist.

After entering the water, tip the housing with the frontglass downwards and check whether everything is watertight. Then you can dive with confidence.

If the equipment has not been used for a prolonged period or perhaps after a service (i.e a. greasing of the shafts, etc.) always test dive first **without the camera fitted**.

Please take note of these points of advice:

- O-rings should be absolutely clean and be greased thinly. We recommend the use of waterproof Silicone grease (eg. SUBAL-Silicone grease). Too much grease results in the accumulation of small dirt particles which are invisible.
- The sealing surfaces must be absolutely clean.
- O-rings must lie in the groove without twisting.

The equipment should be rinsed thoroughly in freshwater after each dive in saltwater. Metal parts, especially threads (screws) should always be greased.

Threaded parts should never be stored assembled without first having been cleaned and dried.

Salt residue should be removed before prolonged storage by placing in freshwater for several days, then dried.

The O-ring of the lid and especially also the front port O-ring should be removed.

Only use original SUBAL-spare parts and SUBAL-accessories.

Have your equipment overhauled from time to time by the manufacturer or by an authorized service center - it is worthwhile.

## USE AND MAINTAINANCE OF O-RINGS

SUBAL housings are designed to use specially formulated O-rings. Replacement by other than genuine SUBAL O-rings may result in leakage. Therefore:

**Use original subal O-rings only!**

The most care is needed with the body O-ring and the port O-ring. Ensure that the O-rings have no mechanical damage like cuts or flat spots. If so, replace them immediately.

Stretching the O-ring a little and feeling it as you slide it between your fingers is a good way of detecting abnormalities.

When closing the housing or changing the port, care should be taken that the sealing surfaces on the housing, the O-ring grooves of the housing and the port and the O-ring itself are absolutely clean.

Remove all dirt particles carefully to prevent water entry.

The sealing surface and the O-ring should be thinly greased with Silicone grease. This reduces friction and abrasion and allows the O-ring to settle into place easily.

Do not use too much grease. Undetected dirt particles could accumulate and would lead to water entry. Take a little bit of grease on two fingers and pull the O-ring between these fingers until it is greased all around. Wipe off excess. The O-ring should just have a sheen.

**Never use hard or sharp metal tools for putting in or removing the O-rings. You could permanently damage the sealing surface or the O-ring itself.**

When inserting the O-ring take care that it is not twisted or is lying undulating in the groove.

The useful life of O-rings is limited in duration depending on care, frequency of use and storage conditions. It is absolutely essential to change them regularly.

Please note that the especially soft quality of the original SUBAL O-ring material loses elasticity prematurely if it is permanently compressed. So, if you plan not to use your housing for a long time, remove the O-ring and store it in a cool place without deformation.

## PREPARING THE CAMERA

The only thing that you should do with your camera before put it into housing, is to remove rubber shield of viewfinder (Fig. 1 & 2).

Knowledge and familiarization with the functions of your camera is essential to avoid mistakes when installing and using the camera. We recommend you study your camera manual thoroughly before installing the camera.



## Mounting the Camera Support Saddle

Attach the camera support saddle to the camera base with the locking lever pointing to the camera backside. Tighten the camera screw by using a coin or a screw driver without excessive force (Fig. 3). Also, please check that metal part of the support saddle on the front, is on the proper position (Fig. 4).



Fig. 3



Fig. 4



Remove the plastic protector of the camera's monitor!

## PREPARING THE LENS

To change the focal length on zoom lenses, or for manual focusing with fixed focal length lenses, special lens gears are required which need to be fitted to the lens barrels.

The SUBAL CD5s accepts gears with 88 teeth and with small change also with 80 teeth!

### Mounting the gear rings

Your housing is set to use 88 teeth gears. If you still have an old gear with 80 teeth, you can also use it with a little change. In that case, only thing that you should do is to unscrew little screw inside knob, axle with a spring will go itself on the right position, and on the end, just tighten screw (Fig. 5).

Depending on the type of the lens, the zooming gear ring is fitted

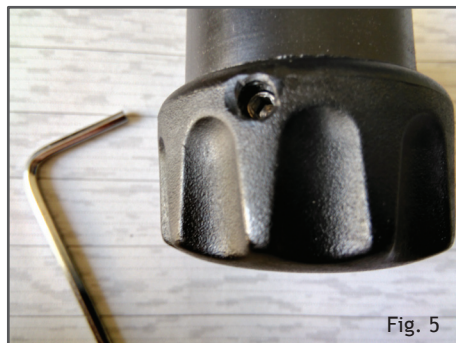

Fig. 5

onto the lens either from the front or from the rear.

Set the zooming barrel of the lens to the mid point of the zoom range. After noting where the zoom drive gear of the housing is located, position the zooming gear ring on the lens in such a way that when the lens is mounted on the camera the centre of the toothed section of the zoom gear aligns with the zoom drive gear in the housing. Check that the gears can mesh over the full zoom range of the lens. A final check should be made after the camera is inserted into the housing.

### Focus gear rings

The different construction of lenses requires different mounting systems of focus gear rings.

Therefore installation procedures vary. Please follow the mounting instructions enclosed with the focus gear ring.

## OPENING THE HOUSING

It is recommended to rinse the housing with fresh water and dry before opening.

When rinsing the housing make sure the port is attached properly and flash sockets are sealed with plugs if no strobes are fitted.

The SUBAL Quicklock System locking levers are spring-loaded and require that they be depressed before rotating.

Do not forcefully turn the levers otherwise damage could occur.



Place the housing on a flat supporting surface with the front surface of the port downwards. Push in the locking levers firmly in the rotating centre (head of the screws) and turn them outwards (Fig. 6 & 7).



Fig. 6



Fig. 7

Lift the lid slowly and carefully to avoid water drips onto the camera.

Now upright the housing and pull out the camera a little bit to enable you to remove the hotshoe connector if provided. Remove the camera.



Some big lenses have to be removed before the camera can be pulled out of the housing.



Fig. 8

## CLOSING THE HOUSING

After checking the body O-ring is clean, lubricated and properly seated in the groove, and the lid sealing surface is also clean and free from any scratches or damage, the hotshoe connector - if provided - is connected properly and all functions are working, the housing lid is put on. The locking levers have to point outwards (Fig. 8).

Check now whether the lid fits correctly and whether the gap between the lid and the front part seems equally spaced all around!

If the lid is lifted again after it was put on, the O-ring might be stuck on the lid and slide out of the groove.

Push in the locking levers firmly in the rotating center (head of the screw) and turn them inwards a quarter of a turn until they click into place, locking them.



The locking levers must be well greased periodically (inside, on the sealing surface area).



Check once again if the gap seems equally spaced all around!

## INSERTING THE CAMERA

In order to facilitate the fitting of the camera into the housing, please take note for the following hints.

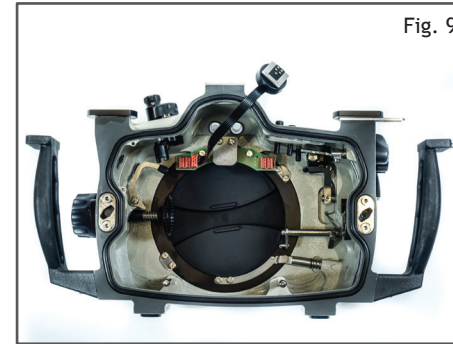

Fig. 9

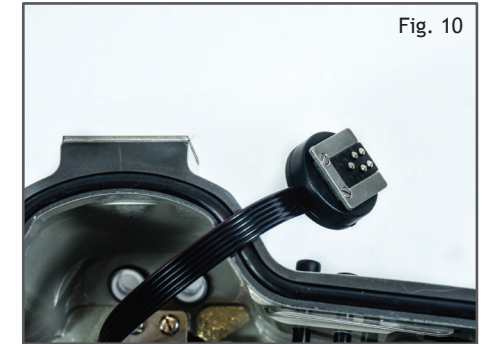

Fig. 10



Fig. 11

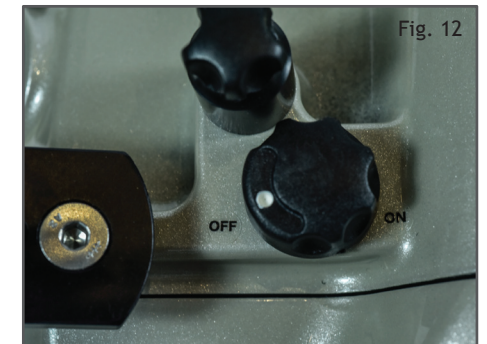

Fig. 12

Open the housing as mentioned above and place the synch cable (hot shoe connector) over the edge of the housing, pointing outwards (Fig. 9 & 10).

Turn the power ON/OFF switch on camera and housing to OFF position (Fig. 11 & 12).

The switch "Photo/Video" have to be in the same position on the camera and housing lid (Fig. 13 & 14).



Fig. 13



Fig. 14

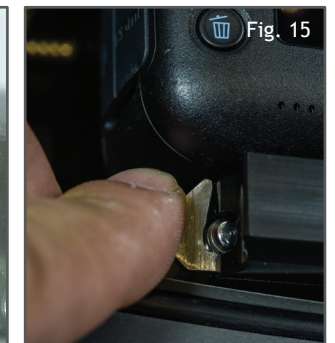

Fig. 15

Put the housing on the front of the port. Take the camera and align the support saddle with the mounting rails inside the housing. Slide the camera into the housing on the mounting rails. Lock the camera support saddle with the locking latch (Fig. 15).

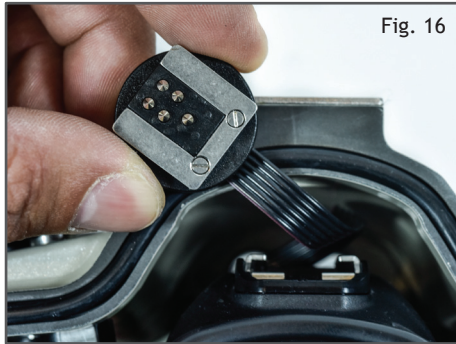

Fig. 16

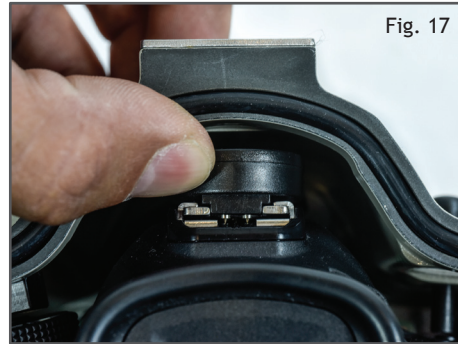

Fig. 17

Insert the synch cord connector in the direction indicated by the arrow on the top of the connector into the camera hot shoe (the cable pointing into the housing) (Fig. 16 & 17).

Check if it works properly. If not, just pull it out again and try once more.

## THE INTERCHANGEABLE PORT SYSTEM

For your SUBAL housing, there is a wide range of front ports available, the largest of all manufacturers. This allows you the use of a multitude of regular lenses under water, ranging from fisheye lenses, extreme wide angle-lenses, zooming lenses and macro lenses up to the 200 mm lens.

### The port O-ring

Please pay attention to all that is advised in chapter *Use and maintainance of O-rings*.

Be sure that the O-ring and the sealing surfaces are clean and lightly lubricated.

### Inserting of the frontport

SUBAL-frontports are attached to the housing by a bayonet mount.

Insert the port (after checking as described above) into the housings bayonet with the white dot or the SUBAL-logo pointing towards the front main dial control knob.

**When pushed in**, turn the port 90° clockwise until it stops. If properly installed, the white dot or the SUBAL-logo is aligned with the middle of the housing.

**After installing check thoroughly that the O-ring is seated correctly in its groove and does not protrude from the housing.**



To remove the port turn counter-clockwise until it stops and then turn back a little bit.

**Do not change the port if it is very warm (eg. through irradiation from the sun, etc.)!**



Synthetic material from which the ports are made expand more than the aluminium housing body and may therefore jam in the mounting.

**When travelling by aircraft the frontport should be left mounted to the housing ONLY if the port O-ring and/or the body O-ring is removed.**



### Cleaning the front glass

The front glass of the ports are to be cleaned carefully to avoid scratches. If possible, rinse well in freshwater, let it drip off and dry carefully with a soft cloth. Dried lime/salt spots are very hard to remove!

Faint scratches are filled in by the water and stay invisible but with greater damage, it may be necessary to replace the front glass.

### Domeports

Domeports are ports with a curved front glass. They are mainly used with wide angle lenses to keep the same angle of coverage under water as on land.

When using domeports for wide angle lenses, please note the following:

- Dome glasses act in water like lenses, creating an apparent image of the actual subject, which is smaller and closer than in reality.
- The lens must be focused on this virtual image.
- The required adjustment of the lens is in the region of 0.15 to 0.3 m, depending on the curvature of the dome.
- A dioptre lens on the camera lens restores the full focusing range under water.

- The required power of the dioptr lens depends on the lens type and the type of the domeport. Without these correcting lenses you may not even be able to get your subject in focus!
- The fogging of the front glasses can be avoided by inserting Silicagel or by applying an antifogging liquid.

## CHANGING A LENS

SUBAL CD5s allows changing the lens without camera removal.

- Unlock the Port Lock (if fitted).
- Remove the frontport.
- Turn the lens release knob clockwise approx. one quarter turn and push it down to release the lens lock mechanism.
- Hold it in position and turn the lens clockwise to remove it.
- Leave the lens release knob, put the new lens onto the camera and attach the proper port.



## OPERATING THE FUNCTIONS

The operation of the camera functions is the same as for surface use: By pressing the corresponding levers, push buttons or turning of the knobs.

If illumination of the subject is insufficient to guarantee proper autofocus operation, additional lighting has to be used (pilot light of flash unit, etc.) or the camera has to be switched over to manual focus.

Therefore a focus gear is required (not possible with all lenses).

### Autofocus mode

Switch the Focus Mode Selector to AF (see camera manual). Lenses with an M - A switch ring have to be set to A.

**In order to avoid straining the focus motor of the camera, the lens focus gear ring (if fitted) needs to be decoupled. Turn the focus coupler lever (below the focus knob) to AF.**

This is not necessary if there is no focus gear on the lens.

If the subject in the picture is out of focus, there are a number of methods available for restoring sharpness:

- Adjust the focus by pressing the shutter release lever slightly until AF activates, keep it half pressed while you compose the picture and shoot.
- Adjust the focus by pressing down the shutter release lever slightly until AF activates. Now press the AF-lock lever (the shutter release lever now can be left) and keep it pressed until you have chosen the wanted frame and have shot your photo.
- Choose the point of autofocus with the Focus Area Selector.

## MOUNTING AND CONNECTING A FLASH UNIT

The SUBAL CD5s is equipped with 2 ports to connect Sea&Sea fiber optic cables. Adapters for other systems (e. g. INON) are available as accessories (Fig. 19).

Modern strobes with STTL function provide full TTL control!

Optionally a built in flash electronic with up to max. 3 strobe sockets is available. This can be upgraded by your local dealer.



If you use your strobes via STTL (Strobe TTL) - connected to the sync ports - the built in strobe of the camera has to be popped up. This will be provided by a push button at the left upper side of the housing. To switch off the internal strobe turn the pear-shaped lever to the left upper side of the housing downwards.

A wide range of perfected strobearms are available for the combination of a SUBAL CD5s housing with SUBAL flash housings and strobes of many manufacturers.

The arms are fastened by pushing them onto an adapter plate on the upper part of the housing. The swivel arm is secured by screwing the footscrew into the center indentation of the adapter plate. For handheld flash operation (point and shooting), the screw needs only to be unscrewed a little and the flash unit removed fortlessly and quickly and can be freely guided.

For other flash arms (eg. Nikonos, Sea & Sea etc.) adapters are available which allow the mounting of the corresponding swivel arms by use of trays (please see accessories).



When inserting the flash unit plug, please take care:

- The socket must be free of sand and moisture.
- The plug O-ring, too, has to be checked carefully for cleanliness and should be lightly greased.
- Note the position of the indexing key and groove and push the plug into the socket without using force, to avoid damage to the contact pins.
- The plug should be pushed in a few millimeters into the socket by hand and only then the knurled screw screwed into the socket and slightly tightened.

In order to guarantee proper flash control, the contacts should be carefully protected from oxidation.

When removing the flash unit from the camera housing, proceed as follows:

While removing the knurled screw, hold the equipment in such a way that the socket and plug point downwards. This allows the water which is in front of the O-ring to drip off. Then pull the plug out slowly, so that the suction effect is as light as possible and no water gets into the contacts. If water has penetrated, it has to be removed by blowing it out and drying. Contact preparations (sprays) are recommended from time to time.

SUBAL TTL-cables have a triple sealed, Nikonos-compatible plug, which prevents water penetrating into the thread of the socket.

The socket is not waterproof with the plug removed.

The red blanking plug must be screwed into the socket(s) if the housing is used without flash unit(s).



## ADDITIONAL ACCESSORIES

For better reaching of Set button, SUBAL also provide additional lever system. For more information, please contact your SUBAL dealer.

## SUBAL CIRCUIT FOR NIKON AND CANON (CONNECTION DIAGRAM)

### CAUTION!

TTL-contacts must be used for digital *NIKON* or *CANON* strobes or other with *NIKON* or *CANON* cameras compatible digital strobes only!  
Using *NON* digital strobes with the TTL contacts may damage the electronics of the camera!



Please contact the producer of your strobe!

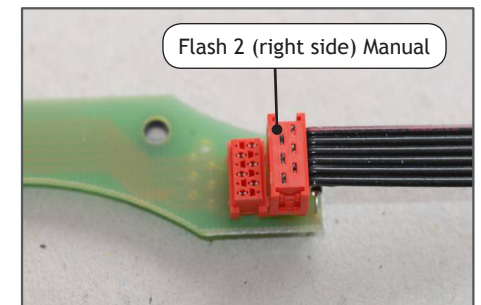
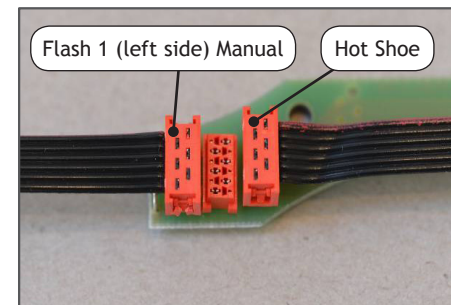
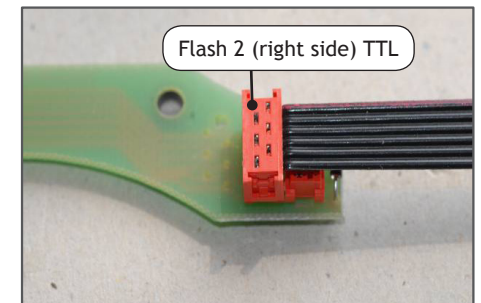
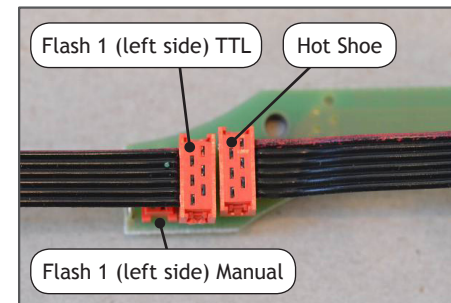

## CHECK-LIST

- After ensuring that the main O-ring has been installed and the housing closed properly, please check carefully **ONCE AGAIN**, whether:
- The gap between the housing front and the lid seems equally spaced all around.
- The gap between the housing front and the port seems equally spaced all around and the O-ring has not been squeezed out.
- The shutter release lever works easily.
- All functions work properly.
- The flash plug(s) are plugged in correctly and tightened and the outside O-ring has not been squeezed out.
- If no flash is used the red plugs must be screwed in.
- The lens cap is removed from the camera lens.
- The frontglass of the port is clean, inside & out.

## GUARANTEE

### Duration of guarantee:

SUBAL CD5s underwater housings are guaranteed against defects in material or workmanship for two full years from date of purchase for consumer use. Housings used commercially are guaranteed for 90 days. The invoice or receipt is valid as guarantee certificate. Keep it safe.

### Conditions of warranty:

The guarantee extends without exception to the rectification of material and production faults of goods manufactured by SUBAL Austria. Faulty parts are exchanged or repaired at the option of the manufacturer. No further claim is possible. Pre-requisite for the right to claim is impeccable care and use of the unit.

No guarantee claim will be accepted without the prior consultation and authorisation of the manufacturer and must be returned freight paid. The guarantee is void after intervention, repair or modification by non authorised persons.

In order to check for transport damage, we recommend that newly delivered units be water tested without the camera or flash unit fitted.

### Repairs:

The unit must be returned freight prepaid to SUBAL Austria or any other SUBAL partner.

# FRONT HOUSING PART EXPLODE VIEW

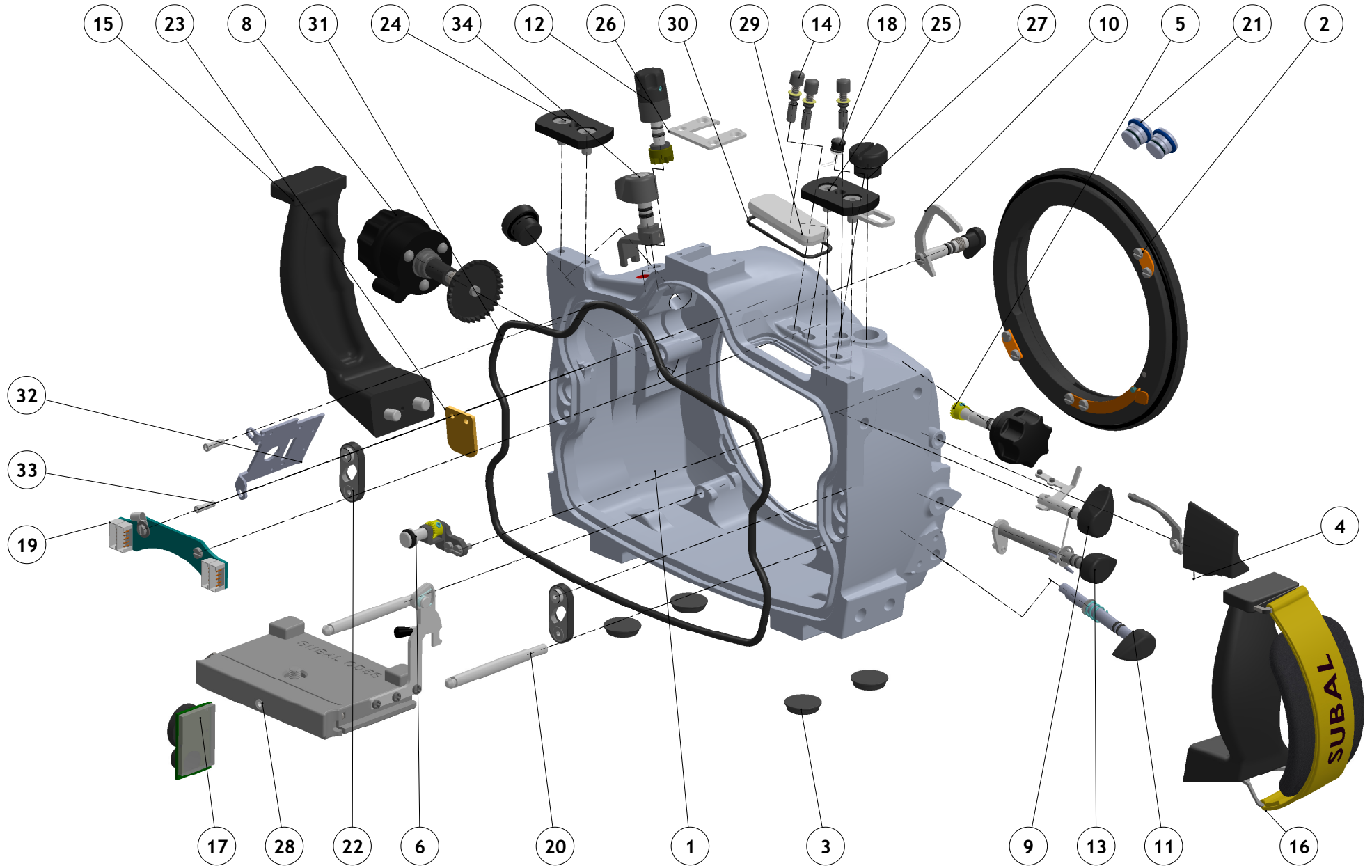

## FRONT PARTS LIST

ITEM NO.	PART NUMBER	QTY.
1	CD5S-VT V2 (EKCD5S-VTV2)	1
2	Ass-Bajonettring BRGT4PS	1
3	Bumpon Elastikpuffer 3M d19 x 4 (EK-610169)	4
4	Ass-CD5MK3-Auslöser	1
5	Ass-CD5MK3-ER vorne	1
6	Ass-CD5MK3-ERv2 vorne	1
7	ZylSchraube M3x8 - DIN85 A4 (EK-1246011)	2
8	Ass-CD5MK3-Fokussierung	1
9	Ass-CD5MK3 LIGHTISO-Modul	1
10	Ass-CD5MK3-Objektivverriegelung	1
11	Ass-CD5MSPortverriegelung	1
12	Ass-CD5MK3-PROGRAM	1
13	Ass-CD5S-Axle for DOF	1
14	Ass-Drucktaste KK mit Kappe 9,5	3
15	Ass_Handgriff-links	1
16	Ass-Handgriff-rechts	1
17	Leckwarner optisch akustisch (EK-500112)	1

ITEM NO.	PART NUMBER	QTY.
18	Ass LED vom Leckwarner	1
19	Leiterplatte Canon	1
20	ND800 - Führungsstab (EK-ND800FS)	2
21	Ass-Sea+Sea Fassung	2
22	Ass-Schlossplattenkomponente	2
23	Stützplatte-ASTPL20-D2HX	1
24	Ass-T-Platte	1
25	Ass-T-Platte rechts	1
26	Zubehörschuh 2	1
27	ASS-Blindstopfen M14x1 POM	2
28	Ass-CD5SKameraschlitten	1
29	CD5MK2-Displayfenster (EK-CD5MK2DF)	1
30	O-Ring 37x1.78 (EK-11 2003 0504)	1
31	O-ring 200x4 - 50 Shore (EK-200x4 NBR50C4)	1
32	TTL-Plexy Mount Plate (optional)	1
33	Hex Socket Head M3x10 - DIN7984 A2 Nach Arbiet (optional)	2
34	Ass-CD5MK3-ONSchalter	1

# BACK HOUSING PART EXPLODE VIEW

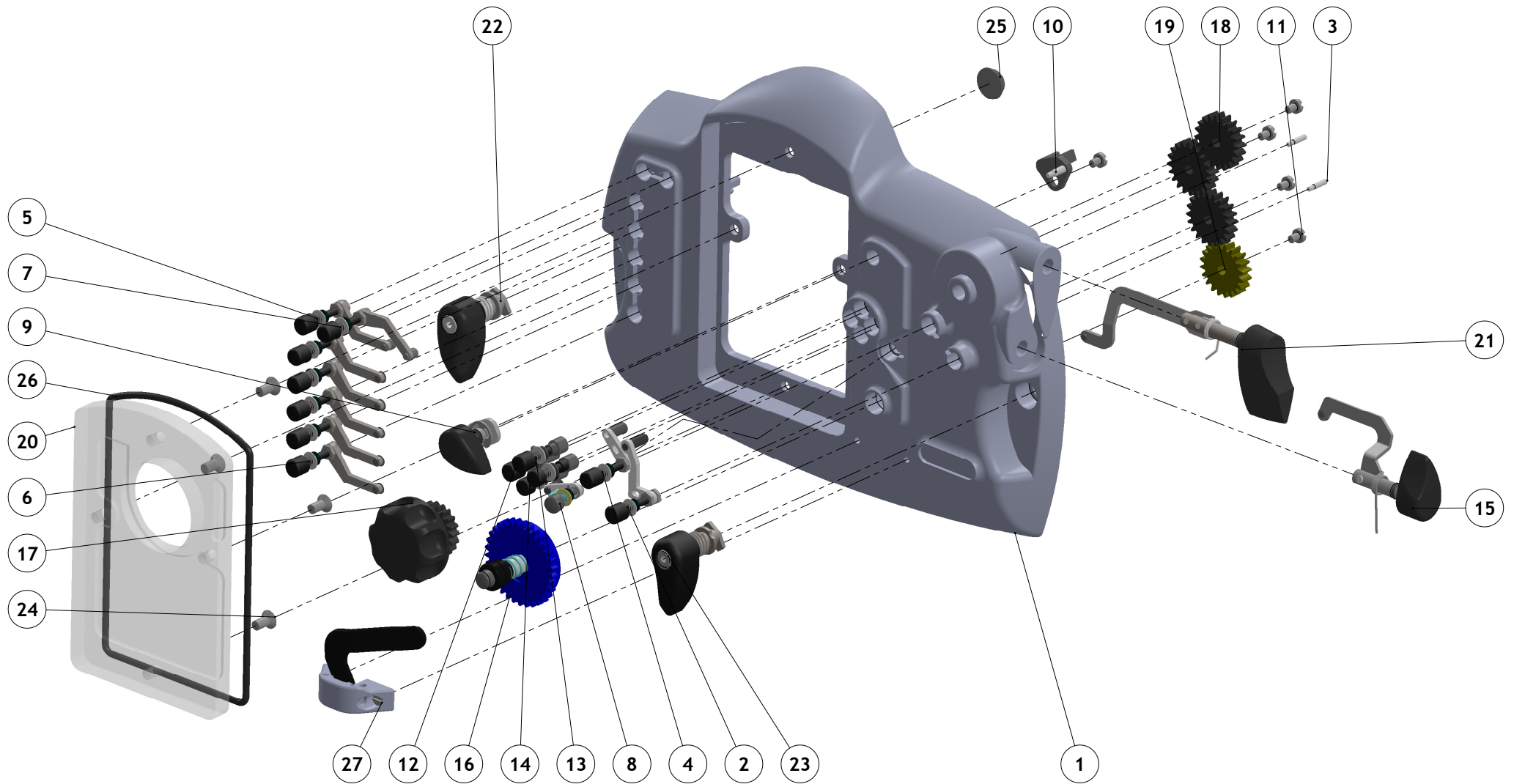

## BACK PARTS LIST

ITEM NO.	PART NUMBER	QTY.
1	CD5S-RT V1 (EK-CD5SRTV1)	1
2	Ass-CD5MK3-Drucktaste Messfelder	1
3	CD5MK3-Führungsstift (EK-CD5MK3-FS1)	2
4	Ass-CD5MK3-Drucktaste Stern	1
5	Ass-CD5MK3-Drucktaste-INFO	1
6	Ass-CD5MK3-Drucktaste-links	5
7	Ass-CD5MK3-Drucktaste-MENU	1
8	Ass-CD5MK3-Drucktaste-Q	1
9	Ass-CD5MK3-FOTOVIDEO-Schalter	1
10	Ass-CD5MK3-Foto-Video-Schalter-2	1
11	ZylSchraube M3x4 DIN85 A4 (EK-1073087)	5
12	ASS-MF1	1
13	ASS-MF2	1

ITEM NO.	PART NUMBER	QTY.
14	ASS-MF3	2
15	Ass-CD5MK3-AF-ON	1
16	Ass-CD5MK3-Einstellrad hinten	1
17	Ass-CD5MK3-ER hinten Knopf	1
18	Zahnrad 20-5-4 (EK-040-0069)	3
19	CD5MK3-Zahnrad-20-nachgearbeitet (EK-040-0069)	1
20	CD5MK3-Sucherplatte-Standard V1 (EK-CD5MK3-SSPV1)	1
21	Ass-CD5MK3-Video-Start	1
22	Ass-Riegel-links	1
23	Ass-Riegel-rechts	1
24	Senkschraube mit ISK M4x8 DIN 7991 A4 (EK-1100173)	4
25	GummifuSchen 12.7x3.5 (EK-527773)	1
26	O-ring 107.62x2.62 (EK-11 2003 1596)	1
27	Ass-Set Lever	1

**Subal GmbH**

Schulgasse 2

1180 Wien

Tel: +43 1409 5897

E-Mail: [austria@subal.com](mailto:austria@subal.com)

**Construction & Engineering - Steyr**

Palais-Werndl

Schönauerstr 7

4400 Steyr

Tel: +43 7252 464 24



**SUBAL**

© 2015.